

PRINCETON

HP-2

Home Digital Piano

CAUTION

Please take a few minutes to read the following pages of instruction and precaution.

1. Please use AC 110V power cord.
2. Use the AC power cord correctly.
3. Avoid injecting water into keyboard or cabinet.
—Don't place containers with liquid on or near the piano. For example vase, cup, wine, etc..
—If a liquid is dispersed into keyboard or cabinet, please turn the power switch off and call the local music dealer or repair technician immediately.
4. Take care in maintaining your cabinet. Avoid direct sunlight and other heat sources.

ASSEMBLY

Make sure that your package contains the following items:

- | | |
|---------------------|--------------------------|
| ① Main unit | ⑤ Real panel |
| ② Pedal board | ⑥ Real panel screws 5PCS |
| ③ Side panel(Left) | ⑦ Side panel screws 4PCS |
| ④ Side panel(Right) | ⑧ Hand screws 4PCS |

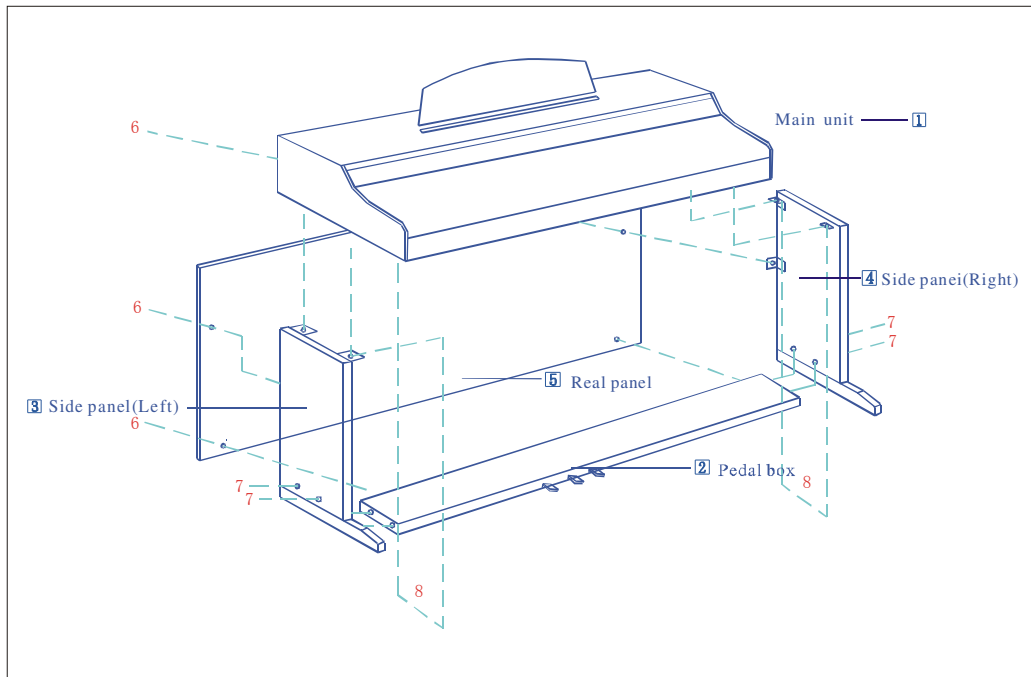

OPERATION

- 1、 Power
Simply push the power button and the power will come on automatically. To turn the power off, simply push the power button again.

2、 Master volume

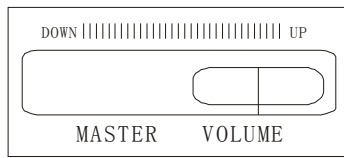

This sliding control button simply adjusts the overall volume of the selected keyboard voice(s)

3、 Demo

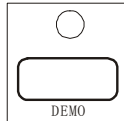

Press the Demo button the LED will begin to flash and the different demonstrations songs can be selected by pressing the individual instrument voice buttons.

4、 Midi

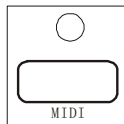

MIDI allows your instrument to communicate with other MIDI-enabled devices.

5、 Timbre

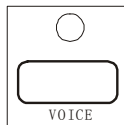

There are fourteen different instrument sounds that can be selected by pressing the individual instruments voice buttons.

6、 Dual

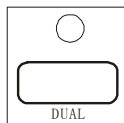

The Dual button allows the user to mix any two of the fourteen instrument voices. Press the instrument button and the voice is selected, pressing any two instrument voices, the voice becomes layered (dual), the proportion of mixing is 50:50.

7、 Split

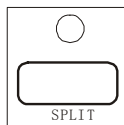

The split function allows the player the opportunity to divide the keyboard into two instrument voice sections.

Press the split button (the LED above the button will blink)

The 88 note piano will be divided, into left and right sections.

The left section is the originally selected instrument voice, the right section is the secondary selected voice. If the instrument voice of right section is not selected, the voice will be the same as original voice. Press the button again to turn the function off.

8、Transpose

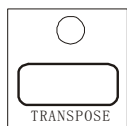

The transposition feature allows the user to transpose or change the overall pitch of the piano to the key of your choice. Press and hold the transpose button while you press a key from F#4 to F5 (press any of these keys on the piano to transpose up or down from C5). To return to “C” just press Transpose and hit key C5 on your keyboard.

9、Tune

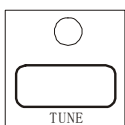

The tune function allows you to adjust slightly the tune of the instrument when it plays with other musical instruments. To adjust, press up or down value button to increase or decrease the tuning by 1 cent. The range of adjustment is -99~+99cent. Press the button again to turn the function off.

10、Metronome

The tempo range is from 40 to 240 BPM and adjusted via the value buttons. The measure button selects the Meter of your choice. (4/4, 4/2, 4/2, 6/8 or fixed).

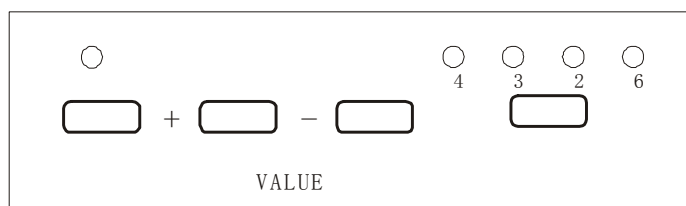

11、Recorder

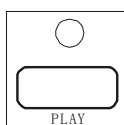
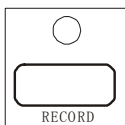

This allows the user to record up to two musical passages and listen to the play back simultaneously.

Press the record 1 button (the LED above the button will turn on) and begin playing;

Press the record 1 button again to stop recording.

Press the play 1 button, the musical passage that you just entered into the musical recorder will playback just as it was performed.

Press the record button, (the metronome will turn on automatically).

Press the Metronome button to stop the function of Metronome.

To erase track 1 or track 2 simply press the record button and then press the play button.

PEDALS

There are three pedals from left to right: the soft pedal, the sostenuto pedal and the sustain pedal.

a). The soft pedal (left): when engaged the keyboard volume is reduced and the timbre slightly

altered.

b) The sostenuto pedal (middle): when engaged the keyboard sustains any key to the left of the middle C piano key that is depressed immediately before the pedal is engaged.

c) The sustain pedal (right): when the sustain pedal is engaged there is a gradual decay for as long as you hold down the pedal.

INPUT/OUTPUT JACKS

1. HEADPHONE JACK



Disconnects internal speakers so you can play in total silence without disturbing others.

2. AUDIO IN/OUT



These jacks connect the output of other electronic instruments to the internal amplifier and speakers within this piano.

3. MIDI JACK

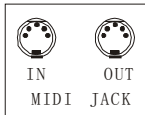

Midi jack allow communication with other products equipped with MIDI interfaces

ABOUT MIDI

1. What is MIDI?

Midi stands for musical instrument digital interface. This is a worldwide standard communication interface that enables musical instruments (of all brands) and computers to communicate so that instructions and other data can pass between them.

2. Midi terminals

A. MIDI IN connector receives MIDI data from an external MIDI device which can be used to control this piano.

B. The MIDI out connector transmits MIDI data generated by this piano. Therefore note and velocity data produced by playing the keyboard.

3. MIDI (implementation chart)

	Function	Receive data.	Transmit data	Others
Basic Channel	Default	1	1-16	
	Channel	1-16	1-16	
Mode	Default	Mode 3	Mode 1	
	Messages	Omni ON/OFF, Poly	Omni ON/OFF, Poly	
	Altered		Mono	

Note Number		15-113	15-113	
	True Voice		15-113	
Velocity	Note ON	O=9n,V=1-27	O=9n,V=1-27	
	Note OFF			
After Touch	Key's	×	×	
	Ch's	×	×	
Pitch Bender		×	×	
Control Change	64(40H)	○	○	Damper
	67(43H)	○	○	Soft
	7(07H)	○	○	Volume
	11(OBH)	×	○	Expression
	10	×	×	Panpot
	32	×	×	Vibrato
	92	×	×	Tremolo
Prog. Change	True		○ (1-127)	
System Exclusive		○	○	
System Common	Song Pos	×	×	
	Song Sel	×	×	
	Tune	×	×	
System Real Time	Clock	×	×	
	Commands	×	×	
Aux Messages	Local ON/OFF	○	○	
	All Note's OFF	×	○ (0-127)	
	Active Sense	○	○	
	Reset	×	×	
Mode1 : OMNION,POLY		Mode2 : OMNI ON.MONO		○ : YES
Mode3 : OMNI OFF,POLY		Mode4 : OMNI OFF.MONO		× : NO

TROUBLESHOOTING

1. The LED does not work
 - Examine if the socket and play is connected correctly
 - AC 110V power cord.
 - Turn the power switch on.
2. The keyboard makes no sound
 - Examine the master volume
 - Make sure headphones are not connected
3. Noise
 - Too close to radio or television receivers, can be interference.
 - The noise from refrigerator or washing machine.
 - Avoid plugging the AC adaptor into the same AC outlet with the above appliance.

TAKING CARE OF YOUR PIANO

- Never apply excessive force to the controls, connectors or other parts of the instrument.
- Avoid direct sunlight and humidity.
- Avoid strong vibrations and movements.
- Avoid excessive dust in and near the keyboard
- Wipe the piano with a soft dry cloth.
- Move the piano away from large electrical appliances
- Avoid contact with liquids
- Avoid placing heavy objects on the instrument.

DIMENSION OF PRODUCT

VBB	PCM(44.1 KHz Sample)
Keyboard	88 Full weighted keys
Voice	Piano1, Piano2, Harpsichord, Glockenspiel, Organ, Guitar, Violin, Guitar, Voice, Trumpet, Saxophone
Adjusting	Volume, Voice, Dual, Split, Transpose, Tune, Touch, Metronome, Value, Recorder/Play, Midi, Demo
Pedal	Output : L/R 250Mv Headphone : 32Ω - 7dB
Automatic output	Soft pedal, Sostenuto pedal, Sustain pedal
Maximal power	30W+30W
Other fittings	MIDI Jack, Headphone Jack
Dimension	1387×435×841
Weight	45Kg

PERCUSSION VOICES SFX (note: not available on all models)

Cattle	Keyboard 68
House	69
Dog	70
Lion	71
Cock	72
Frog	73
Cat	74
Bird	75
Wind	76
Thunder	77
Friction sounds of car	78

Tinkling of bell	79
The sound of car	80
Pig	81
Goat	82
Sheep	83
Sound of running	84
Goose	85
Cuckoo	86
Hen	87
Duck	88

DRUM VOICES (note: not available on all models)

Keyboard	Scale	Standard	Keyboard	Scale	Standard
7	D#0	High Q	40	C 3	High Bongo
8	E 0	Slap	41	C#3	Low Bongo
9	F 0	Scrath Push	42	D 3	Mute Conga
0	F#0	Scrath Pul	43	D#3	Open Conga
11	G 0	Sticks	44	E 3	Low Conga
12	G#0	Square Click	45	F 3	Hi Timbale
13	A 0	Metronome Click	46	F#3	Low Timbale
14	A#0	Metronome Bell	47	G 3	High Agog o
15	B 0	Kick Drum 2	48	G#3	Cabasa
16	C 1	Kick Drum 1	49	A 3	Maracas

17	C#1	Side Stick	50	A#3	Short Whistle
18	D 1	Snare Drum 1	51	B 3	Long Whistle
19	D#1	Hand Clap	52	C 4	Short Guica
20	F 1	Snare Drum 2	53	C#4	Long Guica
21	F 1	Low Tom 2	54	D 4	Claves
22	F#1	Close Hi Hat 1	55	D#4	High Block
23	G 1	Low Tom 1	56	E 4	Low Block
24	G#1	Pedal Hi Hat 1	57	F 4	Open Block
25	A 1	Mid Tom 2	58	F#4	Mute Cuica
26	A#1	Open Hi Hat 1	59	G 4	Open Cuica
27	B 1	Mid Tom 2	60	G#4	Mute Triangle
28	C 2	High Tom 2	61	A 4	Open Triangle
29	C#2	Crash Cymbal 1	62	A#4	Shaker
30	D 2	High Tom 2	63	B 4	Jingle
31	D#2	Ride Cymbal 1	64	C 5	Bell Tree
32	E 2	Chinese Cymbal	65	C#5	Castanets
33	F 2	Ride Bell	66	D 5	Mute Surdo
34	F#2	Tambourine	67	D#5	Open Surdo
35	G 2	Splash Cymbal			
36	G#2	Cow Bell			
37	A 2	Crash Cymbal 2			
38	A#2	Vibraslap			
39	B 2	Ride Cymbal 2			